



COMPACT, SIMULTANEOUS 5-AXIS MACHINING CENTER
FOR HIGH-SPEED MACHINING

DVF

5000



DN SOLUTIONS

DVF 5000

The new DN Solutions DVF 5000 5 axis machining center provides world-class productivity and reliability for simultaneous 5 axis machining operations. Its stable structure and compact footprint is ideal for the production of small to medium size workpieces with complex shapes. The DVF 5000 also features an eco-friendly all-grease lubrication system.



DN Solutions DVF 5-axis models, with their rigid travelling column design and fully integrated tables, are available in a range of sizes. They are ideal for machining everything from small high-precision medical parts through to large aerospace jet engine components. DVF machines are the ultimate simultaneous 5-axis machining centres.



HIGH SPEED, HIGH-PRODUCTIVITY SIMULTANEOUS 5-AXIS MACHINE

- 12000 / 15000 / 18000 r/min high speed spindle
- Ø500 mm (19.7 inch) rotary tilting table (option : Ø630mm (Ø24.8 inch))
- Max. workpiece weight 400kg (881.8 lb)

USER-FRIENDLY MACHINE

- Compact footprint
- Grease lubrication system
- Easy operator access to machine
- Compact automation system (AWC)

HIGH PRECISION FUNCTION

- Integrated thermal compensation systems for spindle and structure
- Spindle cooling provided as standard

BASIC STRUCTURE

Providing stable machining performance with a high-speed, direct-coupled or a built-in spindle.

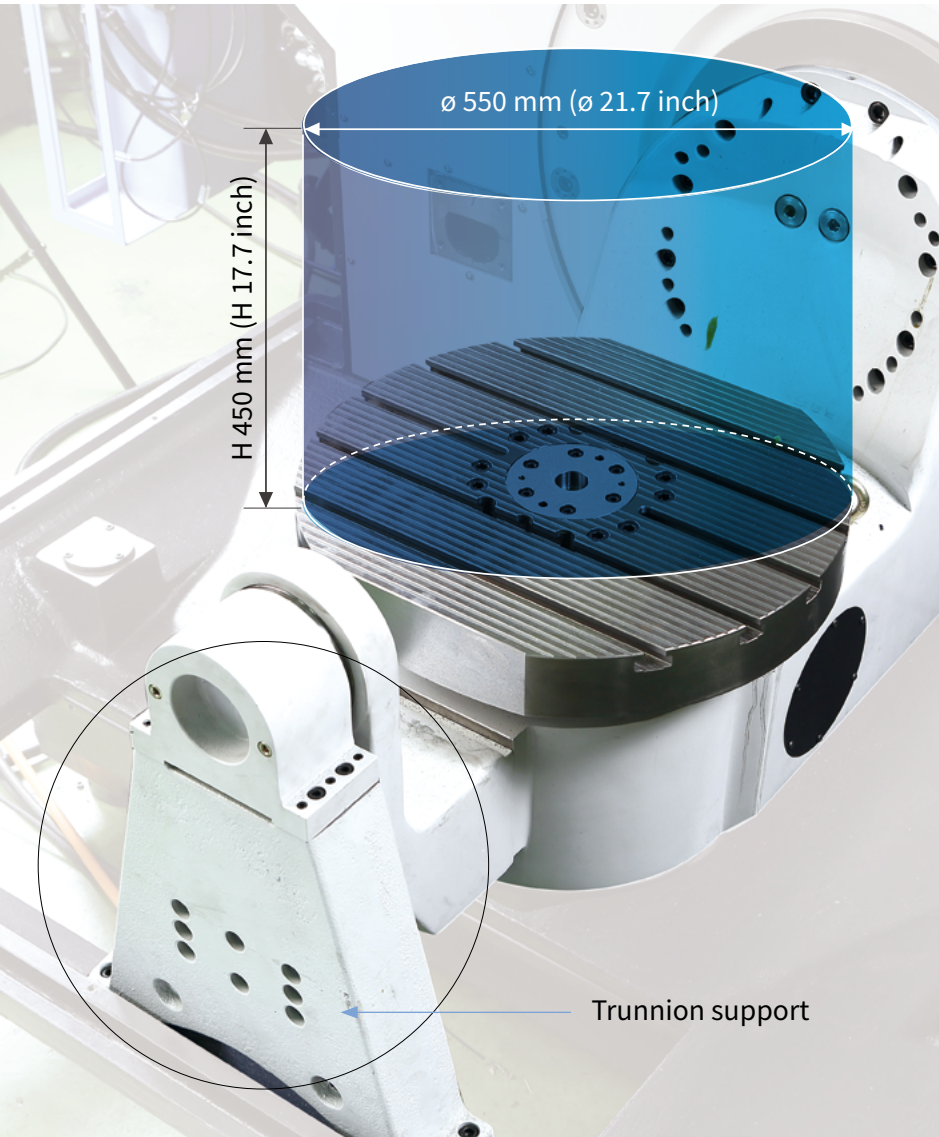

Table size

ø500 x 450 mm
ø19.7 inch x 17.7 inch

ø630 x 450 mm option
ø24.8 inch x 17.7 inch

Maximum workpiece size

ø550 x H 450 mm
ø21.7 inch x 17.7 inch

Maximum workpiece weight

400 kg (WITH TRUNNION SUPPORT)
881.8 lbs

Description		Unit	DVF 5000
Travel distance	X-axis	mm (inch)	625 (24.6)
	Y-axis	mm (inch)	450 (17.7)
	Z-axis	mm (inch)	400 (15.7)
Rapid traverse rate	X-axis	m/min (ipm)	40 (1574.8)
	Y-axis	m/min (ipm)	40 (1574.8)
	Z-axis	m/min (ipm)	40 (1574.8)

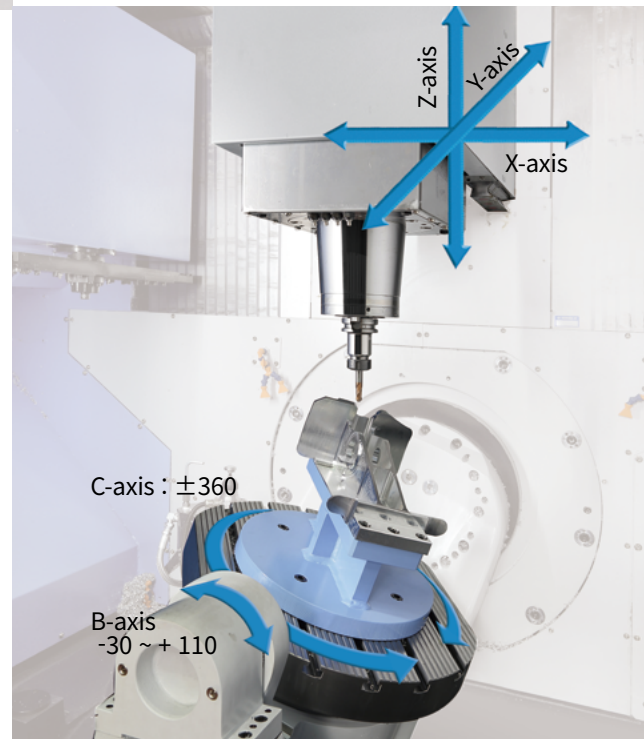

SPINDLE SPECIFICATIONS

Providing stable machining performance with a high-speed, direct-coupled or a built-in spindle.



Maximum speed

12000 r/min

15000 r/min option

18000 r/min option

Maximum power

FANUC: **18.5** kW
24.8 hp

22 kW option
29.5 hp

HEIDENHAIN: **17** kW
22.8 hp

30 kW option
40.2 hp

SIEMENS: **16.5** kW
22.1 hp

30 kW option
40.2 hp

- Oil cooling spindle thermal compensation as standard
- Tool clamp confirmation sensor
- FANUC, HEIDENHAIN, SIEMENS controls

CUTTING PERFORMANCE

From high-speed machining to heavy duty cutting - diverse machining operations for a wide range of complex components are all possible.

Machining performance

Max. chip throughput

Item	Material (SM45C)	Condition
Machining removal rate	599 cm ³ /min	Ø80mm (3.15 in.) Face Mill (6Z)
feedrate	4680 mm/min	
depth of cut	2 mm	
Item	Material (AL6061)	Condition
Machining removal rate	1814 cm ³ /min	Ø80mm (3.15 in.) Face Mill (6Z)
feedrate	9450 mm/min	
depth of cut	3 mm	

* The results presented are provided as examples only. Different cutting and environmental conditions may well deliver different results.

Machining examples

Item	Door Handle (Aerospace)
Material	Aluminum
Cycle time	3 hour 30 min
Tool	Ø12 x R2 Endmill
Spindle speed	8000 r/min
Feed rate	1800 mm/min (70.9 ipm)



Ball bar measurement test

Roundness **3.8 µm**

Feedrate **4000 mm/min 157.5 ipm**

Higher roundness accuracy is realized by the advanced machine design and structure and by DN Solutions's control system.

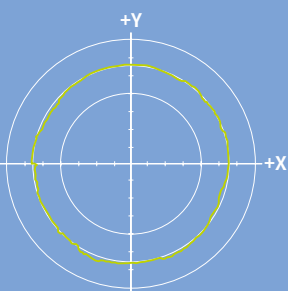

MAGAZINE SPECIFICATIONS

Servo tool magazine delivers high productivity and reliability.



ATC MAGAZINE PANEL

More than 60 tools

- Touch panel 7" (FANUC, HEIDENHAIN)
- Touch panel 8.4" (SIEMENS)
- Touch panel 10.2" (FANUC, HEIDENHAIN)

option



Tool type

ISO #40

Tool capacity

DRUM TYPE **30, 40** tools

CHAIN TYPE **60, 90, 120** tools

Maximum tool diameter

CONTINUOUS **70** mm 3.0 inch

W/O ADJACENT TOOLS **125** mm 4.9 inch

Maximum tool length

300 mm 11.8 inch

Maximum tool weight

8 kg 17.6 lbs

Tool-to-tool

1.3 second

COVER ALL POSSIBILITIES

With cutting-edge technology and an automation-ready framework, this machine elevates your 5-axis capability.



STANDARD | OPTIONAL SPECIFICATIONS

A range of options is available to suit individual requirements.

Description	Features	DVF 5000
Spindle	12000 r/min	●
	18000 r/min	○
Magazine	Tool storage capacity	30 ea ● 40 / 60 / 90 / 120 ea ○
	BIG PLUS BT40	●
Tool shank type	CAT40 / DIN / HSK A63	○
	FLOOD	1.1 KW_0.7 MPA_30 L/MIN ●
Coolant	TSC	None ●
		4.0 KW_2.0 MPA_BUILT-IN FILTER ○
		3.7 KW_3.0 MPA_BUILT-IN FILTER ○
		7.5 KW_7.0 MPA_BUILT-IN FILTER ○
	OIL SKIMMER	None ●
		BELT TYPE ○
Coolant level switch : Sensing level - Low / High		
Chip disposal	Chip conveyor	CHIP PAN ●
		HINGED BELT_LEFT SIDE ○
		DRUM CHIP C/C ○
	Chip bucket	Folklift type ○
		Rotation type ○
	Air gun	○
Coolant gun	○	
Precision machining options	Linear scale	X / Y / Z axis ○
	IKC READY	S/W ONLY ●
RENISHAW (RMI-Q) + S/W ○		
HEIDENHAIN (SE660) + S/W ○		
BLUM (RC66) + S/W ○		
DATUM BALL FOR IKC	NONE ●	
	DATUM BALL_D25 ○	
TOUCH PROBE FOR IKC	NONE ●	
	RMP60_RENISHAW ○	
	TS460_HEIDENHAIN ○	
	TC60_BLUM ○	
Automatic tool measurement	NONE ●	
	TS27R_RENISHAW ○	
	RTS_RENISHAW ○	
	NC4S_RENISHAW ○	
	TT160_HEIDENHAIN ○	
	ZX SPEED_BLUM ○	
MASTER TOOL	NONE ●	
	MASTER TOOL ○	
Others	LED Work light	●
	3 Color signal tower	●
	Tool load monitoring	●
	EZ Guide i	○
	Automatic power off	●
Customized special option	Front _ Auto door (w/saftey edge)	- ○
	Right side _ Auto door (w/saftey edge)	- ○
	Roof_ Auto door	- ○
	Automatic workpiece changer	4 / 6 / 8 / 10 / 12 ○
	Rotary joint for table	Fixture line thru rotary table center (Max.HYD 4port & PNE 2port) ○
	Paper filter with TSC	20 / 30 / 70 BAR ○
	IKC (Intelligent Kinematic Compensation)	DCP-i ○
Kinematic OPT. ○		

Please contact DN Solutions for more information.

● Standard ○ Optional ✕ Not applicable



PERIPHERAL EQUIPMENT

Automatic tool measurement

When using Tool Length Measurement, contact DN Solutions for detailed capacity diagrams

LIMITED USE OF MAX WORKPIECE

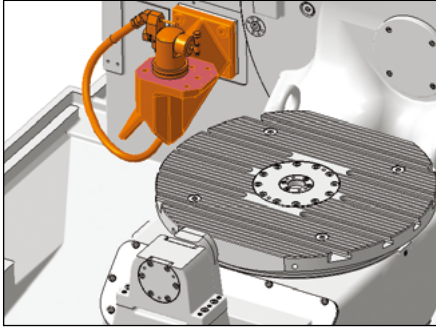

Renishaw (TS27R)

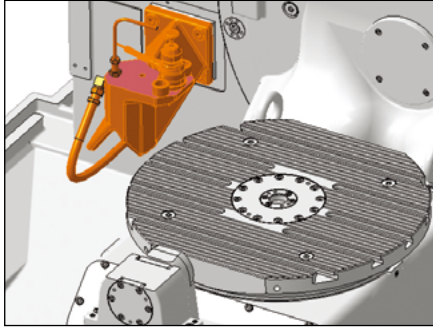

Heidenhain (TT160)

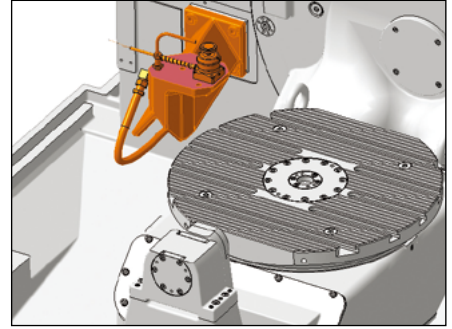

Blum (ZX Speed)

NON LIMITED USE OF MAX WORKPIECE

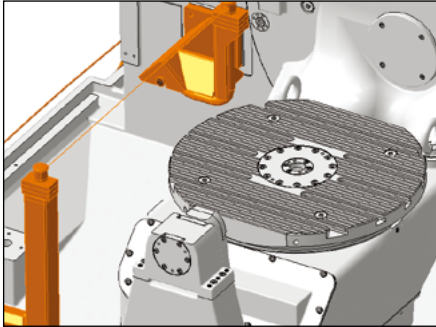

Renishaw (NC4S)

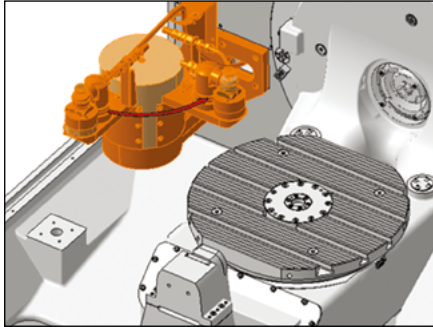

Head separated type
Renishaw NC4S · Blum MICRO SINGLE NT

Tool length measuring

ø550 x 240 mm (Touch type)
ø21.7 inch x 9.4 inch

ø550 x 450 mm
(Laser type / Rotating touch type)
ø21.7 inch x 17.7 inch

Intelligent kinematic compensation for 5-axis machining

For high-accuracy 5-axis machining, the Intelligent Kinematic Compensation function is recommended. This function minimizes errors in complex 5-axis machining applications by maintaining the tool point in the correct position relative to the workpiece.

In order to use this function, the following optional items are required:

SOFTWARE

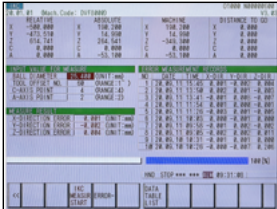

FANUC NC : IKC



HEIDENHAIN NC ; IKC

RECEIVER Recommended Option



TOUCH PROBE Recommended Option



DATUM BALL Recommended Option



AUTO TOOL MEASUREMENT Recommended Option



MASTER TOOL Recommended Option



Touch type

RENISHAW

TS27R

HEIDENHAIN

TT160

BLUM

ZX SPEED

Laser type

RENISHAW

NC4S

BLUM

MICRO SINGLE NT

AWC

An optimized solution from a compact automation system.

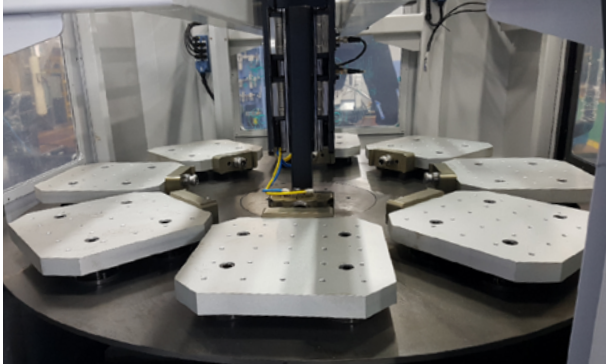

AWC option

A compact automation system providing fast, reliable and high productivity workpiece change capabilities.



Max. workpiece dimensions	Unit	Count	Max. loading	Max. construction height on the pallet
250 x 250 (9.8x9.8) or \varnothing 300 (11.8)	mm (inch)	12	130kg (286.6lb)	350mm (13.8inch)
320 x 320 (12.6x12.6) or \varnothing 360 (14.2)	mm (inch)	10	250kg (551.1lb)	340mm (13.4inch)
350 x 350 (13.8x13.8) or \varnothing 400 (15.7)	mm (inch)	8		335mm (13.2inch)
400 x 400 (15.7x15.7) or \varnothing 450 (17.7)	mm (inch)	6		
500 x 500 (19.7x19.7) or \varnothing 550 (21.7)	mm (inch)	4		

Pallet storage-table configuration

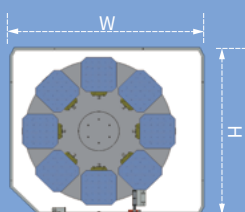

W X H = 1,900 X 1,700
(74.8 X 66.9)

unit : mm (inch)

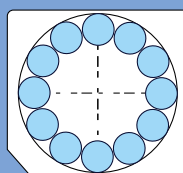

250 X 250
(9.8 X 9.8)

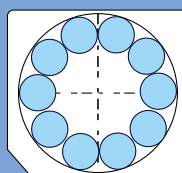

320 X 320
(12.6 X 12.6)

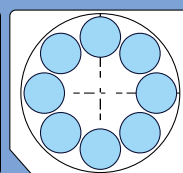

350 X 350
(13.8 X 13.8)

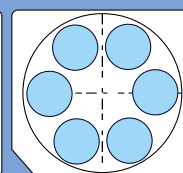

400 X 400
(15.7 X 15.7)

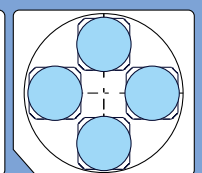

500 X 500
(19.7 X 19.7)

AWC DIMENSIONS

Units : mm (inch)

TOP

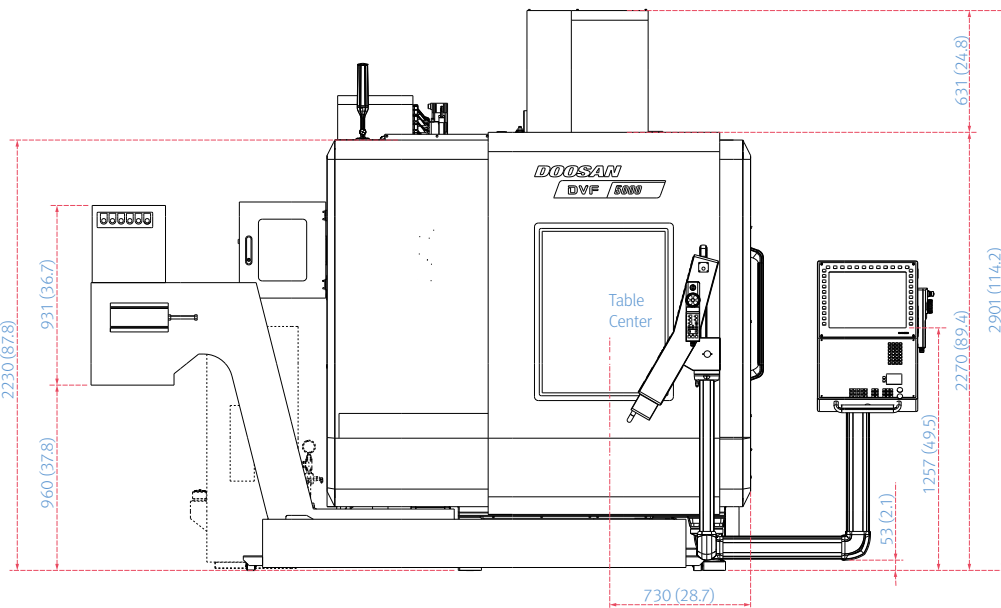
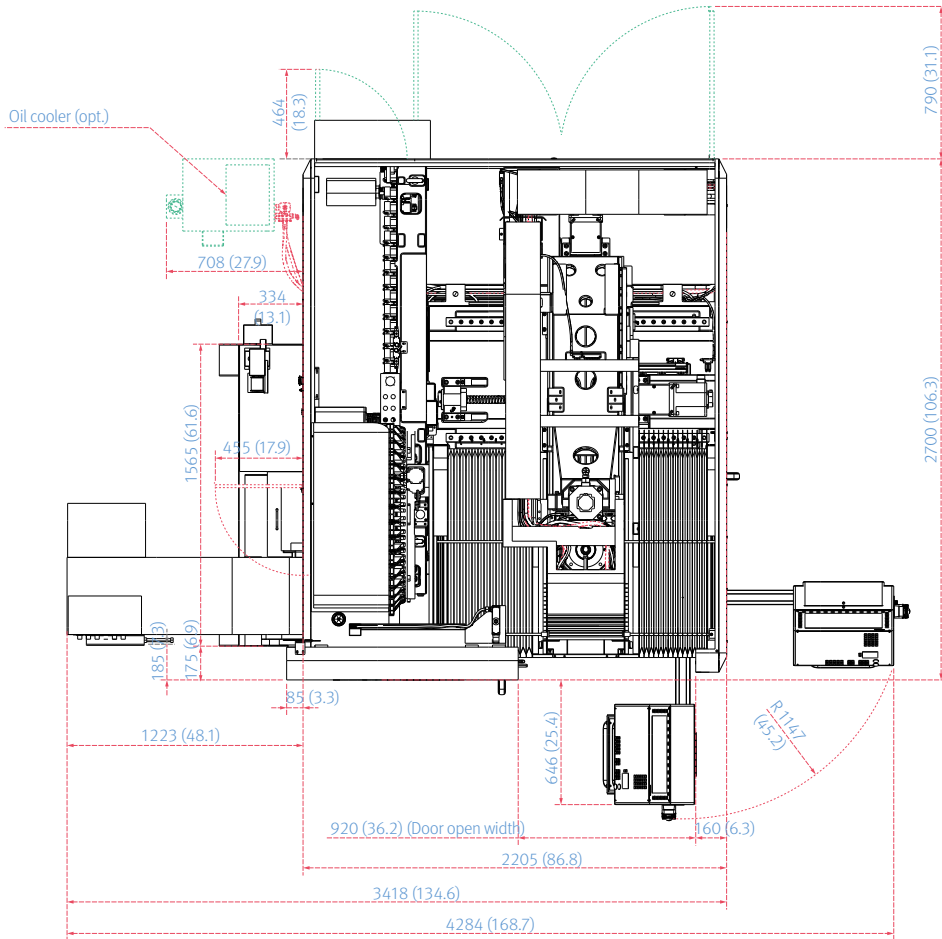

*Some peripheral equipment can be placed in other areas

CUSTOMIZED USER-FRIENDLY FLEXIBLE OPERATION SOLUTIONS

CUFOS is a PC-based control system created by DN Solutions. Equipped with intuitive and user-friendly functions such as a smartphone screen and easy customization, CUFOS helps to improve operators' operational efficiency and performance.

CUFOS FEATURES

USER-FRIENDLY

- 19" multi-touchscreen
- Multiple built-in applications
 - CPS app (Collision Protection System)
 - Turn-cut app
 - Tool management app
 - Status monitoring and alarm guidance app
- Max. program memory : 40GB option
- App-based interface for smartphones and tablet PCs

FLEXIBLE

- Simple connectivity with external software (Cloud, Office, etc.)
- SSD data server app
- PC-based operating system (Windows 7)

CUSTOMIZED

- Simple customization
- Extend functionality with additional apps
- Register up to 6 individual users



CUFOS

CUFOS INTERFACE

User-friendly screen controls

CUFOS, the PC-based control created by DN Solutions, is an integrated system solution using an intuitive 19-inch touchscreen. The system provides a convenient operator interface, a high level of customization and many useful high technology apps.



Intuitive operation via touch screen

Simple customization is available for specific work environments.



Supports various apps in three fields—setup, machining and utility

It provides easy configuration by allowing users to add and edit functions on the home screen according to job requirements.

CUFOS open CNC

CUFOS operation for enhanced productivity

The newly-designed operation panel enhances operating convenience by incorporating common-design buttons and layouts, and features the QWERTY keyboard for fast and easy operation.



CUFOS

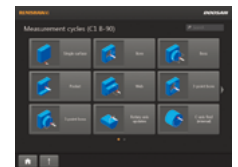
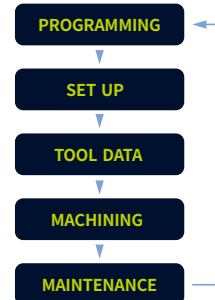

PC software

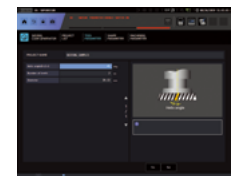

Applications

CUFOS INTERFACE: UTILITIES

Support user convenience functions and additional software modules handling various peripheral devices like measurement.

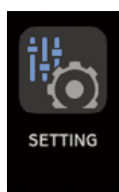

Setting

CUFOS provides management and setting functions such as HMI parameter, user setting, setup manager or e-mail. User setting allows users to register and delete up to six users from the account. CUFOS apps and NC functions can be user-restricted as necessary.

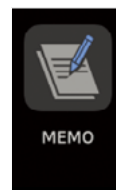

Memo

Users can generate memos, either with a high level of detail via screen capture, or entered by keyboard/touchscreen. The user can add data to existing memos if required. A maximum of 120 memos can be saved



Register up to six user accounts



Screen captures

Memo through touch screen or key board or using a captured screen.

CUFOS: MACHINING

Reduce downtime and improve productivity with Collision Protection System (CPS), real-time status monitoring and maintenance guides during machine operation.



Collision protection system (CPS)

A function to prevent real-time collision in manual mode between the tool and equipment/ machine elements inside the working area.

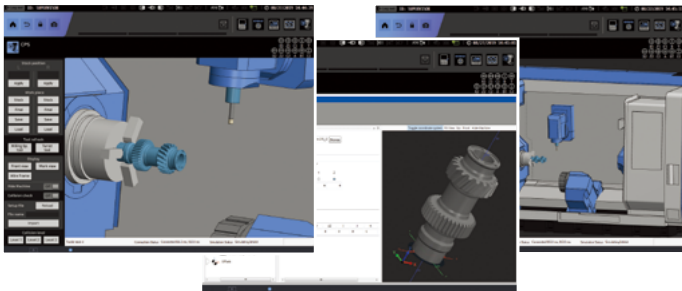

Use the Setup Manager with the CPS app to build up the machine model and add tool, workpiece and workholding equipment details.



SSD data server

As a PC-based NC, it allows the HDD to be used as a storage space for machining programs, saving time for program transfers.



Maximum storage size:

40GB*

Maximum file size:

2GB

Maximum file number:

Up to 1000

(including folder)

*Maximum storage size is determined by the size of SSD in Panel iHPro. If customers need a storage size of 40GB, it is necessary to select SSD129GB (option).



NC control

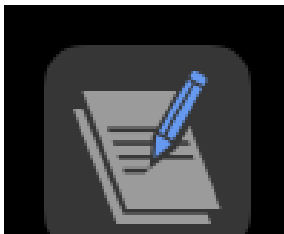

Easy to convert the screen to standard FANUC format for operator convenience.

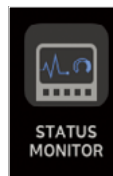

Status monitoring & alarm guidance

Displays the cause and necessary action for NC/ PMC alarms during machine running time. The system can send an email containing the alarm message if the condition persists for a specified time period.



CUFOS: SETUP & UTILITIES

CUFOS: STANDARD | OPTIONAL SPECS



Maintenance manager

Monitors the status of machine and control elements, and confirms the alarm condition and maintenance schedule for preventative machine maintenance.



Video viewer

Video transfer and viewer functions make clearer communication possible between operators, and it facilitates the training of new workers on complex job arrangements.

Video formats:

WMV · AVI · WAV · MOV · MPG · MPEG
MP2 · MP3 · MP4 (same as Windows Media open files)



A diverse range of functions and apps are available to meet your needs.

Description	Features	DVF 5000
Hardware	Display unit	19" color display ●
	Main RAM memory	4 GB ●
	Program storage memory	2 GB ●
		20 GB ○
		40 GB ○
		2 point-touch panel port ●
		Windows® 7 operating system ●
Applications	DN Solutions tool management	X
	Collision Protection System (CPS)	○
	SSD data server application	○
	Set and inspection application (Renishaw)	X
	Manager's message notification application	●
	FTP server service	●
	Smart key access control application	○
	Memo application	●
	Machine status monitor application	●
	Alarm guidance application	●
	Sketch cycle	X
	Sketch turn for CUFOS	X
	CS turncut	X
	BLUM contour scan (BLUM)	X
	Alarm notification via email	●
	iHMI basic application	Manual viewer application
Calendar application		●
Browser application		●
Periodic maintenance application		●
Data logger application		●
Servo viewer application		●

● Standard ○ Optional X N/A

Fanuc 31i/32i Plus

Fanuc 31i/32i Plus maximizes customer productivity and convenience.

15" Touch screen + New OP

DN Solutions Fanuc 31iB/B5 Plus' operation panel enhances operating convenience by incorporating common-design buttons and layout. It features a Qwerty keyboard for fast and easy data input and operation.

Fanuc 31i/32i Plus

- 15-inch color display
- Intuitive and user-friendly design

USB and PCMCIA card QWERTY keyboard

- EZ-Guide i standard
- Ergonomic operator panel
- 4MB Memory
- Hot keys
- Enhance AICC BLOCK
- Touch pen provided as standard



iHMI touchscreen

iHMI provides an intuitive interface that uses a touchscreen for quick and easy operation.

Range of applications

Providing various applications related to planning, machining, improvement and utility, for customer convenience.

NUMERIC CONTROL SPECIFICATIONS

FANUC

	Item	Specifications	F31iB5 Plus
			DVF Series
Controlled axis	Controlled axes		5 (X,Y,Z,C,A) (X,Y,Z,C,B)
	Simultaneously controlled axes		5 axis
	Additional controlled axis	Add 1 Axis (5th Axis)	●
Data input/output	data server		○
	Memory card input/output		●
	USB memory input/output		●
Interface function	Embedded Ethernet		●
	Fast Ethernet		○
	Enhanced embedded ethernet function		●
Operation	DNC operation	Included in RS232C interface.	●
	DNC operation with memory card		●
Program input	Workpiece coordinate system	G52 - G59	●
	Addition of workpiece coordinate system	G54.1 P1 X 48 (48 pairs)	●
	Tool number command		T4 digits
Feed function	Tilted working plane indexing command	G68.2 TWP	●
	AI contour control II	G5.1 Q_, 1000 Blocks	●
Operation Guidance Function	High smooth TCP		●
	EZ Guide i		●
Setting and display	EZ Operation package		●
	CNC screen dual display function		●
Network	FANUC MTConnect		✳
	FANUC OPC UA		✳
Others	Display unit	15" color LCD with Touch Panel	●
		10240M(4MB)_1000 programs	●
		20480M(8MB)_1000 programs	○
		2560M(1MB)_2000 programs	○
		5120M(2MB)_4000 programs	○
		10240M(4MB)_4000 programs	○
		20480M(8MB)_4000 programs	○

Network: FANUC MTConnect and FANUC OPC UA available.

● Standard ○ Optional ✕ Not Available ✳ Available

EZ WORK

The software developed by DN Solutions's own technology provides numerous functions designed for convenient operation.

EZ work

The EZ work package delivers speed and efficiency. This menu-driven innovation not only helps customers reduce setup times, but also simplifies common tasks and procedures, reducing the potential for errors. EZ work reduces operating time, protects machinery, enhances quality and speeds up maintenance interventions.

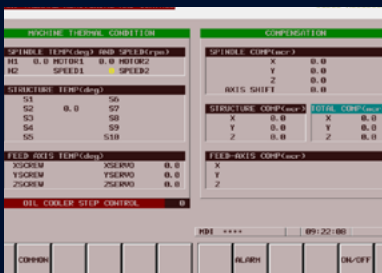

Thermal Compensation

A function to maintain high-precision machining quality by analyzing and correcting the amount of thermal displacement of a structure through a temperature sensor



M/G-Code List

Functional description of M code and G code



Tool Management

Function to manage tool information [Tool information / Tool No. / Tool condition (normal, large diameter, worn / damaged, used for the rst time, manual) / Tool name]

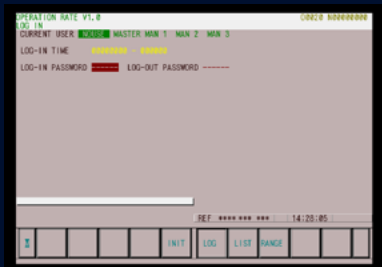

Operation Rate

Machine operation history management function by date based on load



Adaptive Feed Control

Function to control feedrate so that the cutting can be carried out at a constant load

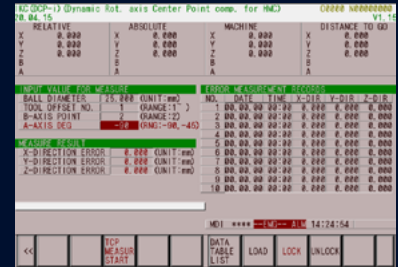

IKC (DCP-I)

The function to compensate the position of the workpiece and the tool tip to be constant regardless of the rotation of the rotating shaft error

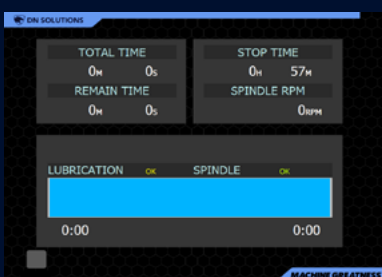

Spindle Warm Up

A function that assists spindle warm-up for spindle life when the spindle has not been used for a certain period of time



ATC Recovery

Function to view detailed info with recommended actions and to perform step-by-step operation manually (when an alarm is triggered during an ATC operation)

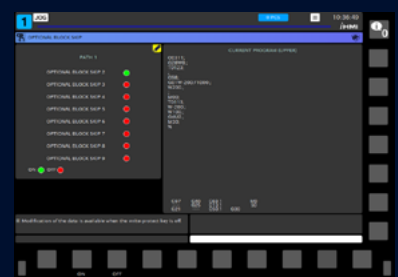

Addition of Optional Block Skip

In addition to the OPTIONAL BLOCK SKIP of the operation panel, the function to skip a specific block selected in the machining program

CONVENIENT OPERATION

Heidenhain TNC640

Superior hardware specifications

The TNC 640 features optimized motion control, short block processing times and special control strategies. Together with its uniform digital design and its integrated digital drive control (including inverters), it enables you to achieve high machining speeds and the best possible contour accuracy.

- 15.6" display
- 21GB Storage memory
- 1024 look ahead blocks
- High user convenience with folder structure data management

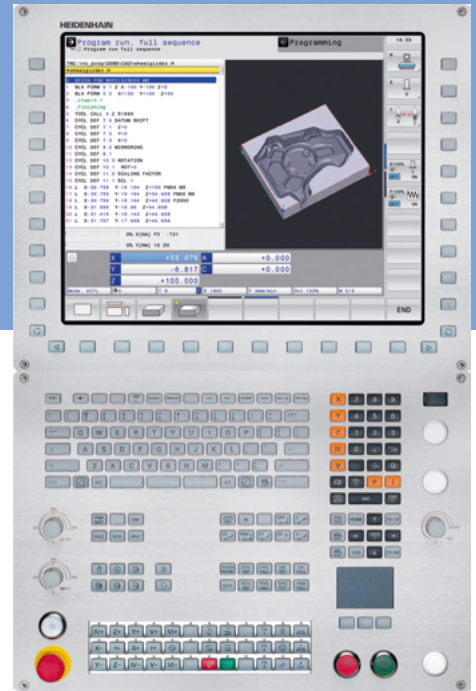

Conversational convenient function

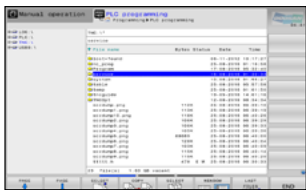

Data are controlled in the folder structure; convenient communication via USB devices

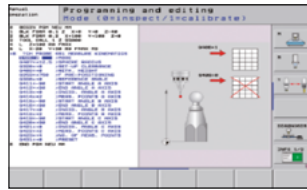

KinematicOpt & KinematicComp option
(Touch probe cycle for automatic measurement)

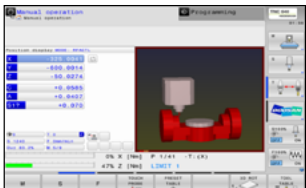

Collision protection system option

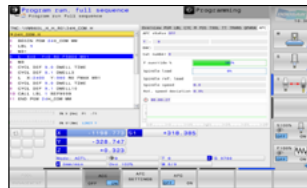

Adaptive feed control option



Various built-in pattern cycles for a wider scope of application (Software standard)

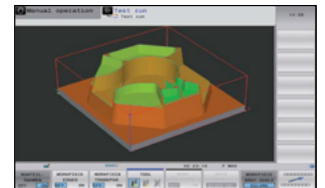

Graphic simulation

NUMERIC CONTROL SPECIFICATIONS



Item		Specifications	TNC640
			DVF Series
Controlled axis	Controlled axis		5 (X,Y,Z,C,A) (X,Y,Z,C,B)
	Simultaneously controlled axis		5 axis
Data input/output	USB memory input/output		●
Interface function	Embedded ethernet		●
Feed function	Look-ahead	5000 blocks	●
Axis compensation	KinematicsOpt	Automatic measurement and optimization of machine kinematics	●
Collision monitoring	Dynamic collision monitoring (DCM)		○
Network	MTConnect		⊗
Others	Display unit	15" color LCD	●
		15" color LCD with touch panel	○
	Part program storage size & number of registerable programs	21 GB	●

● Standard ○ Optional ✕ Not Available ⊗ Available

CONVENIENT OPERATION

Siemens 840D

15.6" screen + new operation panel

The newly-designed operation panel improves the customer convenience by incorporating and using common-design buttons and layouts, and includes the familiar QWERTY keyboard for fast and easy operation.

- 15.6" display
- 10MB high capacity user memory
- USB & ethernet (standard)
- QWERTY keyboard (standard)
- High-speed calculation and simulation can be fulfilled by improved processor functionality



Conversational convenient function

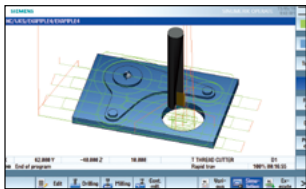

Simulation and machining contour monitoring

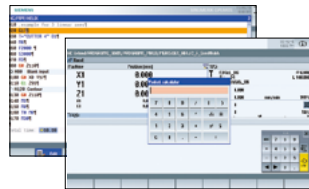

Smart function

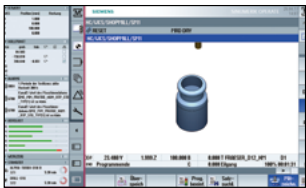

Side screen widget

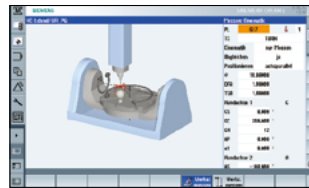

5-axis kinematic measuring cycles

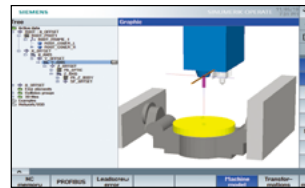

3D collision avoidance and collision avoidance ECO

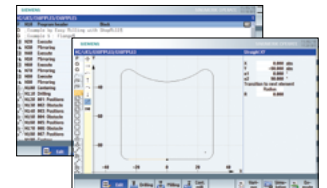

Shop mill part programming

NUMERIC CONTROL SPECIFICATIONS

SIEMENS

	Item	Specifications	S840Dsl DVF 5000
Controlled axis	Controlled axes	5 axes	●
	Simultaneously controlled axes	5 axes	●
Data input/output	Memory card input/output	(Local drive)	●
	USB memory input/output		●
Interface function	Ethernet	(X130)	●
Operation	On network drive	(without EES option, Extcall)	●
	On USB storage medium, e.g. memory stick	(without EES option, Extcall)	●
Program input	Workpiece coordinate system	G54 - G57	●
	Addition of workpiece coordinate system	G505 - G599	●
Interpolation & feed function	Advanced surface		●
	Top surface		○
Programming & editing function	Look ahead number of block	S/W version 4.8	1000
	3D simulation, finished part		●
	Simultaneous recording		●
	Measure kinematics		●
Operation guidance function	DXF Reader for PC integrated in SINUMERIK Operate		○
	ShopMill		●
Setting and display	EZ Work		●
	Operation via a VNC viewer		●
Network	MTConnect		⊕
	OPCUA		○
Etc. function	15.6" color display with touch screen		●
	19" color display without touch screen		○
	21.5" color display with touch screen		○
	CNC user memory	10 MB	●
	Expansion by increments	2 ~ 12 MB	○
	Collision avoidance		○
Collision avoidance ECO (machine, working area)		●	

POWER | TORQUE

FANUC

12000r/min Direct

Power 18.5/11 kW (24.8/14.8 Hp)
Torque 118 N·m (87.1 ft-lbs)

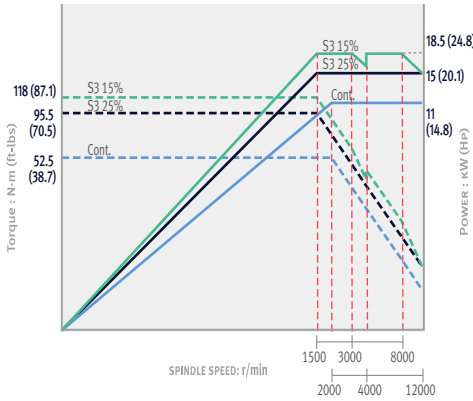

15000r/min Direct option

Power 18.5 kW (24.8 Hp)
Torque 117.8 N·m (86.9 ft-lbs)

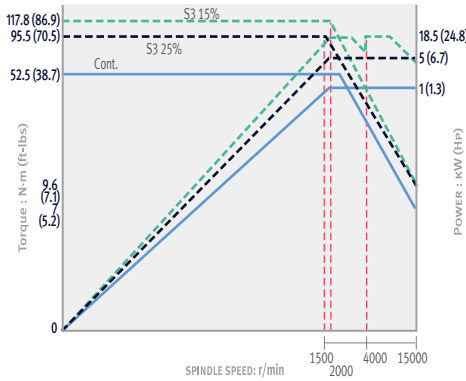

18000r/min Built-in option

Power 22/18.5 kW (29.5/24.8 Hp)
Torque 118 N·m (87.1 ft-lbs)

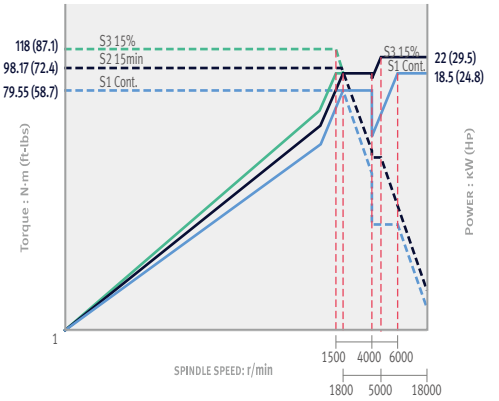

HEIDENHAIN

12000r/min Direct

Power 17/10 kW (22.8/13.4 Hp)
Torque 118 N·m (87.1 ft-lbs)

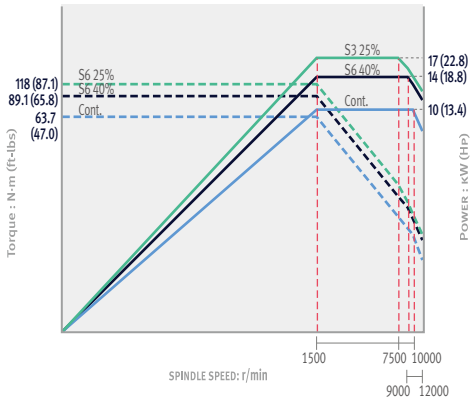

15000r/min Direct option

Power 17 kW (22.8 Hp)
Torque 108.6 N·m (80.1 ft-lbs)

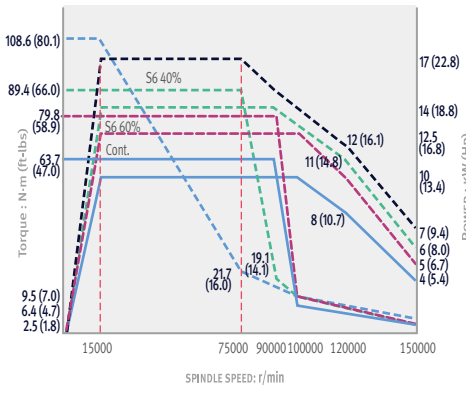

18000r/min Built-in option

Power 30/24 kW (40.2/32.2 Hp)
Torque 155 N·m (114.4 ft-lbs)

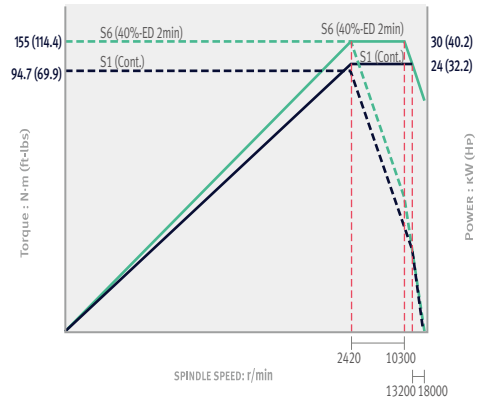

SIEMENS

12000r/min Direct

Power 16.5/11 kW (22.1/14.8 Hp)
Torque 79 N·m (58.3 ft-lbs)

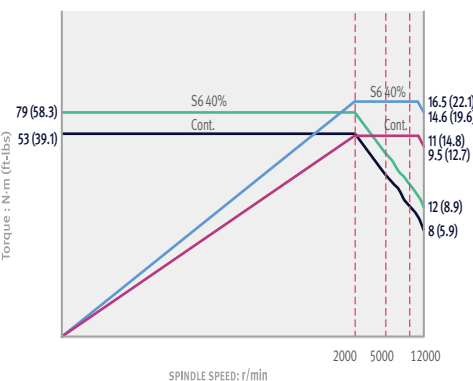

15000r/min Direct option

Power 16.5/11 kW (22.1/14.8 Hp)
Torque 79 N·m (58.3 ft-lbs)

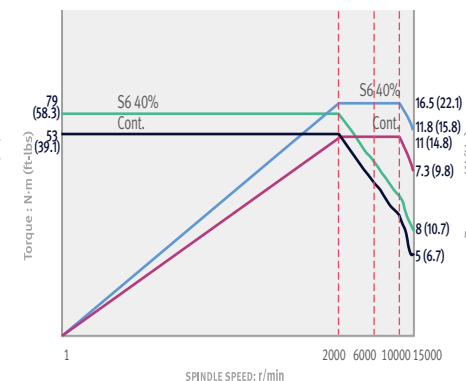

18000r/min Built-in option

Power 30/24 kW (40.2/32.2 Hp)
Torque 155 N·m (114.4 ft-lbs)

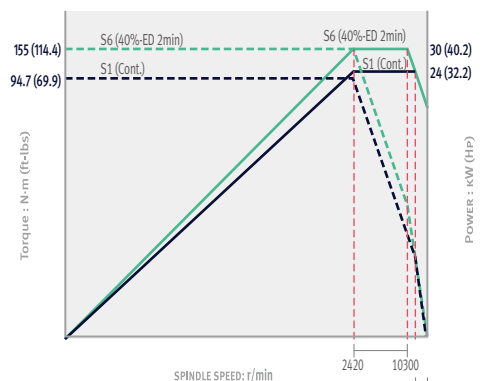

DIMENSIONS

Units : mm (inch)

TOP

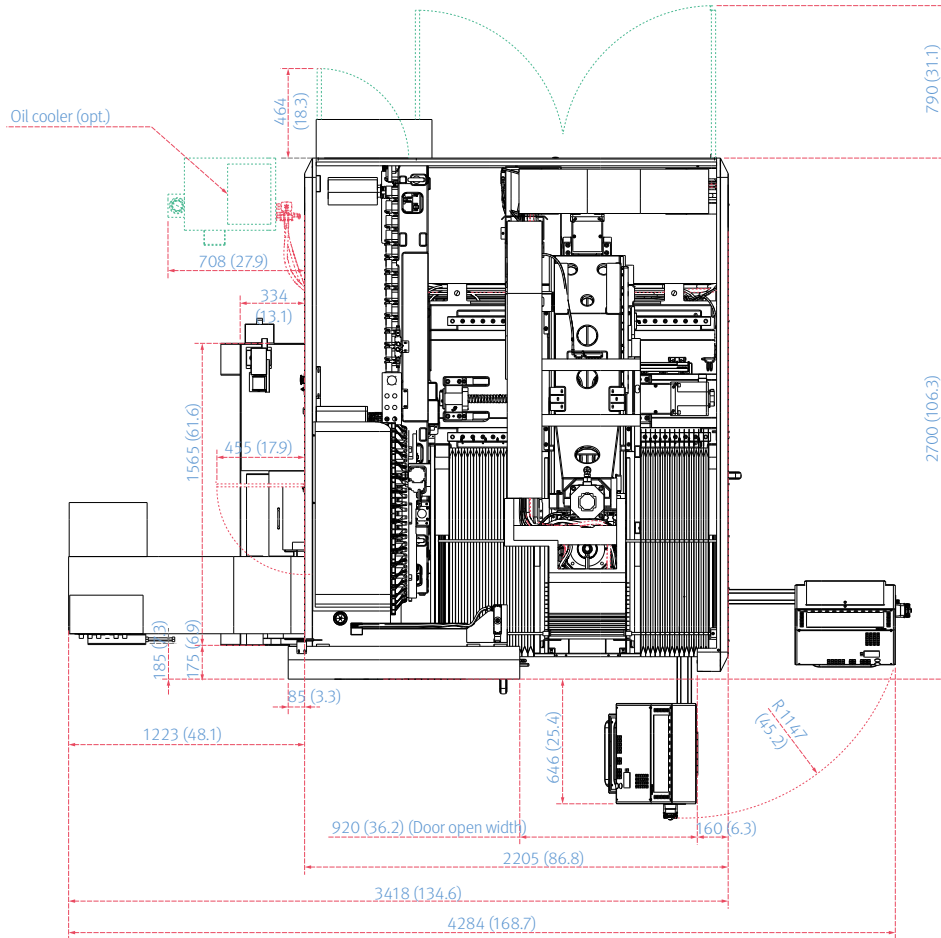

FRONT

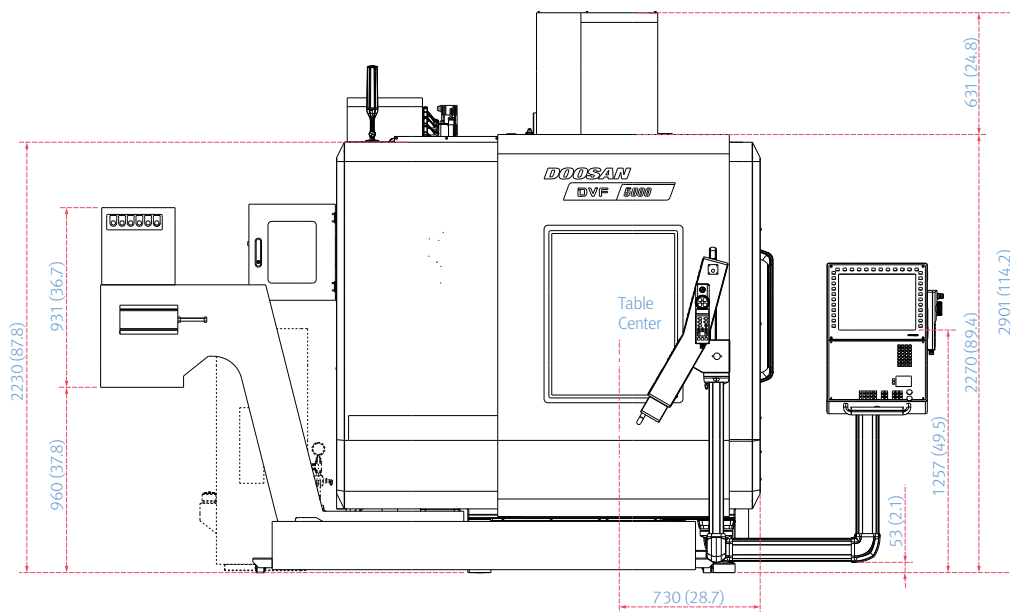

*Some peripheral equipment can be placed in other areas

INTERFERENCE

Units : mm (inch)

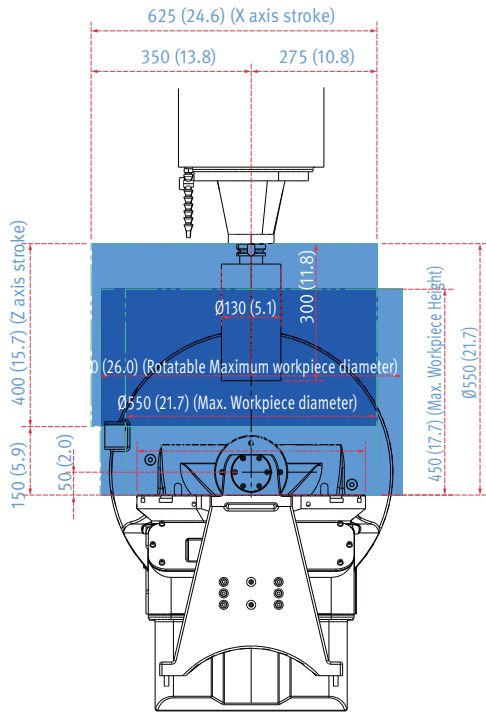

Front view (1:10)

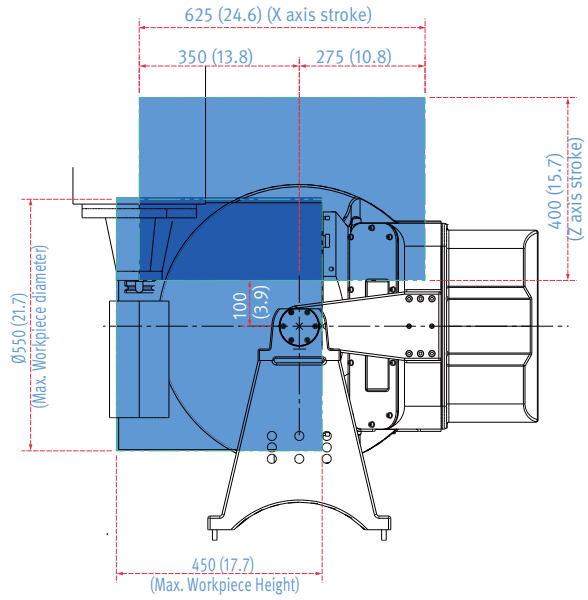

Front view (1:10)

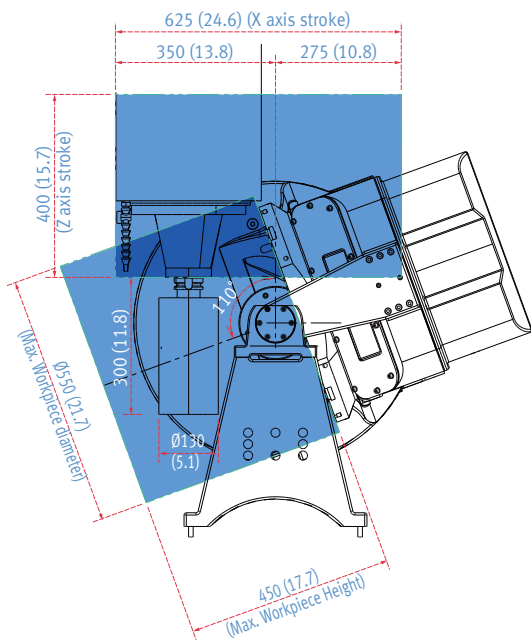

Front view (1:10)

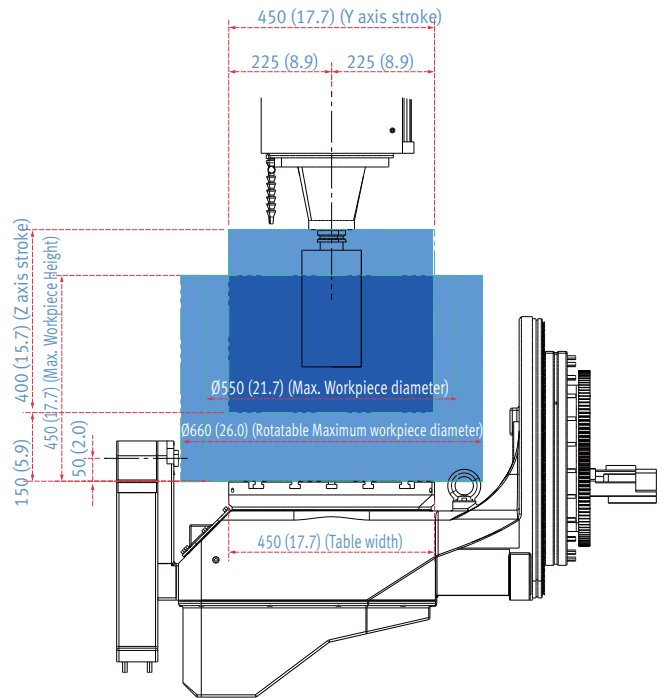

Right view (1:10)

MACHINE SPECIFICATIONS

Description		Unit	DVF 5000	
Travels	Travel distance	X axis	mm (inch)	625 (24.6)
		Y axis	mm (inch)	450 (17.7)
		Z axis	mm (inch)	400 (15.7)
		B axis	deg	-30 ~ +110
		C axis	deg	360
Table	Table size		mm (inch)	∅ 500 x 450 {∅ 630 x 450}* (∅ 19.7 x 17.7 {∅ 24.8 x 17.7})
	Max. workpiece size		mm (inch)	∅ 550 x h 450 (∅ 21.7 x h 17.7)
	Table loading capacity		kg (lb)	400 (881.8)
Spindle	Max. spindle speed		r/min	12000 {15000, 18000}*
	Max. spindle power (S3/Cont.)		kW (Hp)	Fanuc : 18.5 {22}* (24.8 {29.5}) H/H : 17 {30}* (22.8 {40.2})
	Max. spindle torque		N · m (ft-lbs)	Fanuc : 118 {118}* (87.1 {87.1}) H/H : 109 {155}* (80.4 {114.4})
Feedrate	Rapid traverse rate	X axis	m/min (ipm)	40 (1574.8)
		Y axis	m/min (ipm)	40 (1574.8)
		Z axis	m/min (ipm)	40 (1574.8)
		B axis	r/min	20
		C axis	r/min	20
Automatic tool changer	Type of tool shank	Tool shank	-	ISO #40
	Tool storage capa.		ea	30 {40, 60, 90, 120}*
	Max. tool diameter	Continuous	mm (inch)	75 (3.0)
		Without adjacent tools	mm (inch)	125 (4.9)
	Max. tool length		mm (inch)	300 (11.8)
	Max. tool weight		kg (lb)	8 (17.6)
	Tool change (Tool-to-Tool)		sec	1.3
Tank capacity	Coolant tank capacity		L (gal)	410 (108.3)
Machine dimensions	Height		mm (inch)	2890 (113.8)
	Length		mm (inch)	2205 (86.8)
	Width		mm (inch)	2700 (106.3)
	Weight		kg (lb)	7500 (16534.4)
Control	NC system		-	CUFOS / F31iB5 Plus / HEIDENHAIN TNC640 / SIEMENS S840D

*{} : Option

WHY 5-AXIS MACHINING?

Single setup efficiency

5-axis machining allows you to approach the workpiece from all angles, with complete access to five sides of the part in a single setup. This reduces the overall number of part setups compared to traditional machining, which minimizes machine downtime and maximizes chip making time.



Improved part accuracy

When making parts with multi-sided features using traditional 3-axis machining, multiple part setups are required. This means new inaccuracies can arise each time the workpiece is repositioned. 5-axis machining eliminates stacked tolerances and improves overall part dimensional accuracy.

Extended machine shop capability

DN Solutions 5-axis machines open up new doors for your machine shop. The increased efficiency will make you instantly more competitive, and full 5-axis machining capabilities give you the opportunity to quote on jobs that previously weren't possible. So, what are you going to make today?



“Compared with similar machines from Japan or Europe, DN Solutions has the same level of precision and quality at a better value for money.”

– OMGM Group, Italy

“Our DN Solutions 5-axis is making complex, high precision parts for aerospace and defense. Cycle times have been reduced dramatically.”

– Aerotech Precision Manufacturing, Great Britain

The DN Solutions promise, MACHINE GREATNESS, has two important meanings. The first is simple: DN Solutions makes great machines. The second is a challenge to our end-users. With a product line that is this comprehensive, accurate and reliable, we equip our customers to machine greatness. The big question: ***Why should you choose DN Solutions over other options?***

Here's why...



**MACHINE
GREATNESS™**



WHAT YOU MAKE AND HOW YOU MAKE IT MATTERS—SO MAKE IT GREAT WITH DN SOLUTIONS.

UNBEATABLE MACHINES

You won't find a more comprehensive range or a better combination of value, performance and reliability anywhere else.

ROBUST PRODUCT LINE

We offer an impressive range of machine models and hundreds of configurations. Whatever your machining needs and requirements, there's a DN Solutions for you.

READILY AVAILABLE - ANYWHERE IN THE WORLD

Machining centres (including 5-axis machines), lathes, multi-tasking turning centres and mill-turn machines, and horizontal borers with best-in-class specifications are all available...ready to install.

EXPERT SERVICE

Our dedicated, experienced and knowledgeable team is totally committed to improving your productivity, growth and success.

CUSTOMER SUPPORT AND SERVICES

We're there for you whenever you need us.

We help our customers operate at maximum efficiency by providing them with a range of tried, tested and trusted services - from pre-sales consultancy to post-sales support.

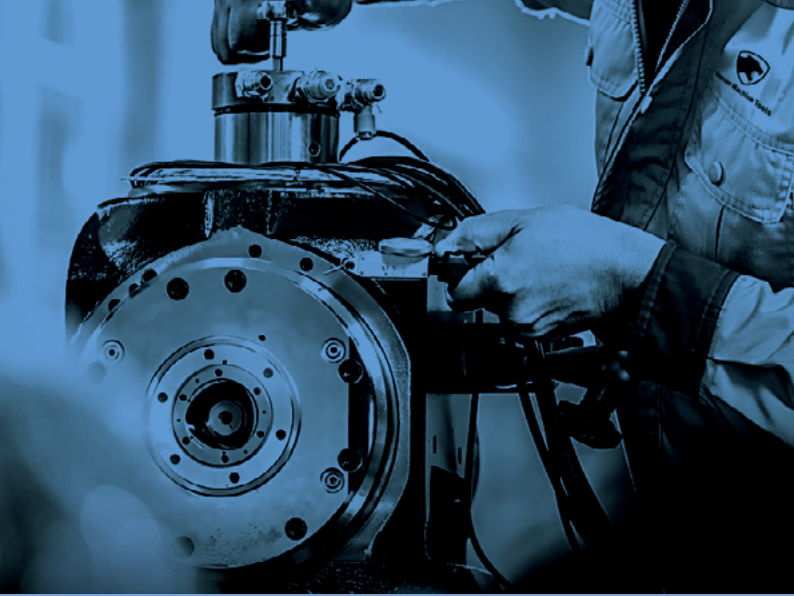

FIELD SERVICES

- On-site service
- Machine installation and testing
- Scheduled preventive maintenance
- Machine repair service



PARTS SUPPLY

- Supplying a wide range of original DN Solutions spare parts
- Parts repair service



TRAINING

- Programming, machine setup and operation
- Electrical and mechanical maintenance
- Applications engineering



TECHNICAL SUPPORT

- Supports machining methods and technology
- Responds to technical queries
- Provides technical consultancy

RESPONDING TO CUSTOMERS ANYTIME, ANYWHERE

DN Solutions Global Network

DN Solutions provides systems-based professional support services, before and after the machine tool sale, by responding quickly and efficiently to customers. By supplying spare parts, product training, field service and technical support, we provide the expert care, attention and assistance our customers expect from a market leader.



Global sales and service support network

4	Corporations
156	Dealer networks
51	Technical centers Technical Center, Sales Support, Service Support, Parts Support
200	Service posts
3	Factories





dn-solutions.com

Head Office

22F T Tower, 30, Sowol-ro 2-gil
Jung-gu, Seoul, Korea, 04637

Tel: +82-2-6972-0370/0350
Fax: +82-2-6972-0400

DN Solutions America

19A Chapin Road, Pine Brook
New Jersey 07058, United States

Tel: +1-973-618-2500
Fax: +1-973-618-2501

DN Solutions Europe

Emdener Strasse 24, D-41540
Dormagen, Germany

Tel: +49-2133-5067-100
Fax: +49-2133-5067-111

DN Solutions India

No.82, Jakkuar Village
Yelahanka Hobli, Bangalore-560064

Tel: + 91-80-2205-6900
E-mail: india@dncompany.com

DN Solutions China

Room 101,201,301, Building 39 Xinzhuan
Highway No.258 Songjiang District
China Shanghai (201612)

Tel: +86 21-5445-1155
Fax: +86 21-6405-1472

Sales inquiry

sales@dncompany.com

* For more details, please contact DN Solutions.

* Specifications and information contained within this catalogue may be changed without prior notice.